



**DESIGN YOUR
OWN AFFORDABLE
LOG CABIN OR
GAZEBO ONLINE
IN OUR FREE
3D CONFIGURATOR**



Made-to-order
garden rooms



WOODPRO

**AFFORDABLE QUALITY AND CUSTOMISATION
WITHOUT ANY ADDITIONAL CHARGES!**



WELCOME

WOODPRO offers log cabins, garages and gazebos at **affordable quality**.

And with us, you will not be faced with any unpleasant surprises. Where you often incur additional costs such as nail sets, foundation beams, roofing, double glazing and delivery, etc., this is **all already included with Woodpro**.

Our production facility covers an area of more than **70,000 m²** and we produce many thousands of log cabins every year. We control the entire production process ourselves, which enables us to offer the best **quality and service**.

We only use **high-quality spruce wood**, which is extracted from the coldest areas. As a result, trees grow slowly and the annual rings are closer together. This makes the wood more stable and durable.

We also dry the wood so that the top-hung and shrinkage of the wood is limited. Windows, doors and posts are laminated to prevent warping.

Have fun viewing and designing!

TEAM

WOODPRO



CONTENTS

4	Benefits
5	All sizes and possibilities at a glance
6 - 7	Colour treatments
8 - 9	Explanation and pictures of our standard included benefits
10 - 11	Explanation and pictures of our quality windows and doors
12 - 13	Configurator explanation
14 - 31	Log cabins with a flat roof and a canopy
32 - 43	Log cabins with a flat roof
44 - 57	Log cabins with an apex roof and a canopy
58 - 63	Log cabins with an apex roof
64 - 69	Gazebos with a flat roof and an apex roof
70 - 72	Garages with flat roof and an apex roof
73	Templates/3D configurator explanation page
74	Windows and doors

STANDARD BENEFITS

Always included in our price



All windows and doors are fitted with double glazing as standard



All windows, doors and posts are made of laminated wood (prevents warping)



All windows and doors are a whopping 4.5 cm thick

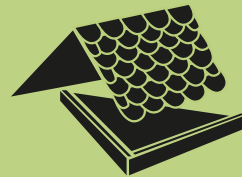

Including complete roof package EPDM + roof outlet, sealant and wide aluminium roof trims for flat roofs or a choice of five colour shingles for apex roofs



Delivered with pressure impregnated foundation beams

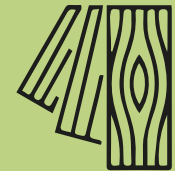

We use top-quality dried spruce wood (with PEFC quality mark)



Including all the necessary fixing materials



5-year warranty on manufacturing and construction faults



Home delivery

The dimensions below exclude the roof overhang. To calculate the total size including overhang, add 60 cm (30 cm for each side) to the dimensions below.

Alleen 28 mm	150 x 150 cm	150 x 200 cm	150 x 250 cm	150 x 300 cm	150 x 350 cm	150 x 400 cm	150 x 450 cm
28 of 44 mm	200 x 150 cm	200 x 200 cm	200 x 250 cm	200 x 300 cm	200 x 350 cm	200 x 400 cm	200 x 450 cm
28 of 44 mm	250 x 150 cm	250 x 200 cm	250 x 250 cm	250 x 300 cm	250 x 350 cm	250 x 400 cm	250 x 450 cm
28 of 44 mm	300 x 150 cm	300 x 200 cm	300 x 250 cm	300 x 300 cm	300 x 350 cm	300 x 400 cm	300 x 450 cm
28 of 44 mm	350 x 150 cm	350 x 200 cm	350 x 250 cm	350 x 300 cm	350 x 350 cm	350 x 400 cm	350 x 450 cm
28 of 44 mm	400 x 150 cm	400 x 200 cm	400 x 250 cm	400 x 300 cm	400 x 350 cm	400 x 400 cm	400 x 450 cm
28 of 44 mm	450 x 150 cm	450 x 200 cm	450 x 250 cm	450 x 300 cm	450 x 350 cm	450 x 400 cm	450 x 450 cm
Alleen 44 mm	500 x 150 cm	500 x 200 cm	500 x 250 cm	500 x 300 cm	500 x 350 cm	500 x 400 cm	500 x 450 cm

ALL MODELS ARE AVAILABLE IN MORE THAN 100 SIZES

You can choose from:



Flat roof



Apex roof

You can choose from:



Canopy left, right, front or rear.



Choose your (optional) size of canopy there. You can choose between: 150 cm, 200 cm, 250 cm, 300 cm, 350 cm, 400 cm, 450 cm or 500 cm.

You can choose from:



Choose your (optional) walls under the canopy. You can choose between: 150 cm, 200 cm, 250 cm, 300 cm, 350 cm, 400 cm, 450 cm or 500 cm (depending on wall thickness).

THE (COLOUR) TREATMENTS

Pressure impregnation *(low maintenance)*

The wood is placed in a large boiler, filled with impregnating agent, and is vacuum drawn. This causes the impregnating agent to be pressed into the wood.

Pressure impregnated wood is low maintenance and can be kept for at least 10 years in all weather conditions. Also, in principle, it no longer needs any treatment, but you do extend the lifespan of the woodwork and keep the look fresh and beautiful if you do treat it. It is best to treat pressure impregnated wood with a wood oil. This is easy to process and is absorbed nicely.

Tip! If your log cabin is not easily accessible on one or more sides, we recommend having your log cabin pressure impregnated.

Windows and doors are not pressure impregnated. However, you can choose to have them pre-treated or to have them delivered completely painted.



Brown

Spray impregnation

(pre-treatment)

With spray impregnation, all interior and exterior surfaces are pre-treated with an impregnating agent (primer). You can choose from four different transparent colours. In addition to these colours, you also have the option of having us treat your product with a colourless primer.

BENEFITS:

The inside of your log cabin and the parts that are no longer accessible after assembly are protected and you do not need to stain them in the future.

With this treatment, your cabin is already provided with a primer.

Your log cabin is immediately protected against mould and decay processes after assembly. Your cabin will need to be stained on the outside within 12 months. Within 6 months if white, and as soon as possible if colourless.

Choose from five colours, and you can choose multiple colours:

Windows/doors: 1 colour

Walls/roof: 1 colour

Floor: 1 colour

So in total, you can choose a maximum of three colours per cabin.



Colourless



White



Graphite grey



Windows and doors

If desired, we can paint your windows and doors for you.

- We stain your windows and doors (exterior and interior) in two layers
- 5-6 years protection
- We work with the quality mark: Johnstones

You can choose from:



RAL 7037 - Dusty grey

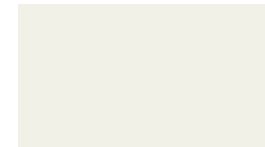

RAL 9010 - Pure white

WOODPRO

**ALL PRODUCTS ARE
DELIVERED UNTREATED
AS STANDARD**



Oak brown

Light grey

With opaque white stain, it is possible that brown / yellow stains (resin from the trunk) become visible.

Despite the use of an impregnating agent and stain, this is unavoidable and therefore no reason for complaints.

www.lomaxwoodgardenrooms.co.uk

THERE ARE MANY BENEFITS AT WOODPRO INCLUDED AS STANDARD IN THE PRICE



Includes complete roof package: EPDM

Complete EPDM package: rubber roofing, roof outlet and sealant included. Also included are wide aluminium roof trimmings for finishing the roof edges on flat roofs.

Double glazing

All windows and doors come with double glazing.



Dried and laminated

All the wood is dried to reduce shrinkage. In addition, the windows, doors and posts are laminated to prevent warping as much as possible.

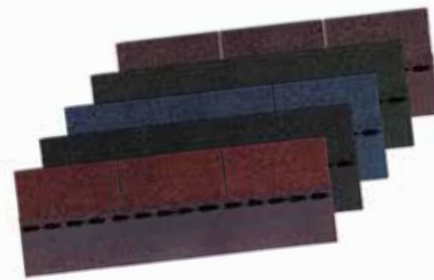

Included for free: choice of five colours of shingles

If you choose an apex roof, the shingles are included in the price. Here, you can choose from the colours: blue, brown, green, red or black.





Mounting and fixing materials

All mounting and fixing materials are included.

Stacked wood construction system

In all our log cabins, the wall sections are stacked on top of each other and no nails or screws are needed. The log cabins are manufactured with a high wind and watertight corner connection.

Wall thickness

28 mm



Wall thickness

44 mm



Wooden interior floor (optional)

The wooden interior floor comes with pressure impregnated beams, 19 mm floorboarding and is finished with beautiful decorative skirting boards.



Posts, feet and foundation beams

All posts are laminated (prevents warping) and are 9 x 9 cm thick. Posts are delivered with pressure impregnated wooden feet. Pressure impregnated foundation beams are included as standard with every log cabin.



HIGH-QUALITY FINISHING OF WINDOWS AND DOORS

Double glazing

All windows and doors come with double glazing.



Cylinder locks

All doors are equipped with a high-quality cylinder lock, including a set of keys.

Window handles and expanders

Windows can be opened by means of a button. The expanders of the casement windows are adjustable, so that you can open the window ajar or completely. Because of the pin and hole connection, the window does not break when there is wind. The espagnolette in the frame ensures that your window is tightly closed along its entire length.



Window expander

This window expander is included with the windows. The expander allows you to open the window in the desired position.

Door handles

Door handles are finished in chrome and spring-loaded.

Doors

The doors have a thickness of no less than 4.5 cm.

Clickable cross bars

The rods have a clicking system. This is very useful when painting and cleaning the windows.



Wear strip

All doors are equipped with an aluminium wear strip with pre-drilled screw holes. This wear strip protects your sill.



Tilt and turn mechanism

Tilt and turn windows are very solid and have a high-quality mechanism.

Draught strips

All doors and windows are fitted with draught strips. These come with plastic foil that you can remove after painting.

Windows sealed

All windows are fully sealed by us.



Adjustable split hinges

The hinges are adjustable in all directions.

Covers for a beautiful finish

We supply covers for each hinge to give them a nice finish.



CONFIGURATOR EXPLANATION

1 Go to www.woodpro-configurator.com/brochure
Enter the product code next to the log cabin to open it. Start adjusting the cabin.

Tip! For each step, you will find the options at the bottom of the page. You can find info about the product by pressing the .

2

Make your log cabin bigger or smaller and choose the desired wall thickness. If necessary, add a canopy and walls to your log cabin. It is also possible to add a substructure, so that your log cabin has a double space with a partition.

3

Choose your roof type here.

4

Select your doors here and then position them in the wall at the desired location.

5

Select your windows here and then position them in the wall at the desired location.

6

Make your choice from the various (colour) treatments.

7

Optionally select your other choices and/or options here.

8

Here you can see the total overview. You can also send in your design here (without obligation) and ask questions if necessary.

You will immediately see your own designed log cabin, gazebo or garage in 3D. You will also see the price and floor plan. And... with us, everything is included! No hidden additional costs.

CREATE YOUR OWN DESIGN FOR FREE IN OUR UNIQUE 3D CONFIGURATOR

Start



Specified quotation

Full floor plan

Your design



Various colour treatments
available

More than 20 different types of
windows and doors

End result



360 degree rotation function

Thousands of sizes and designs

WWW.WOODPRO-CONFIGURATOR.COM

LOG CABINS WITH A FLAT ROOF AND A CANOPY



STANDARD ADDITIONS

ALWAYS INCLUDED WITH US



All windows and doors are fitted with double glazing as standard



All windows, doors and posts are made of laminated wood (prevents warping)



All windows and doors are a whopping 4.5 cm thick

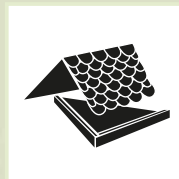

Includes complete roof package: EPDM for flat roofs



Pressure impregnated foundation beams



We use top-quality dried spruce wood

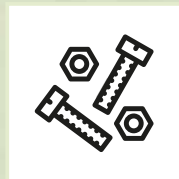

Including all the necessary fixing materials



5-year warranty on manufacturing and construction faults



Would you like to fully adjust a model to your own wishes? You can!
 Go to the website:
woodpro-configurator.com/brochure and enter the **product code**

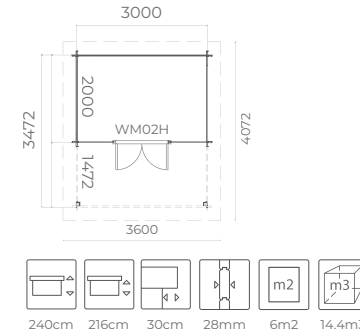

Dimensions excl. roof eaves: 350 x 300 cm
Door: WM02H
Product code: 26275

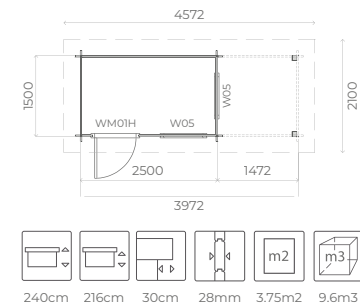

Dimensions excl. roof eaves: 150 x 400 cm
Door: WM01H
Windows: 2 x W05
Product code: 25113

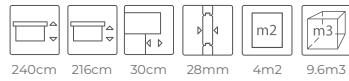
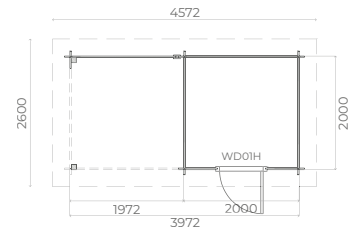

Dimensions excl. roof eaves: 200 x 400 cm
Door: WD01H (R/H hinged)
Product code: 26151

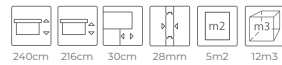
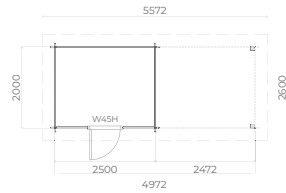

Dimensions excl. roof eaves: 200 x 500 cm
Door: W45H
Product code: 25111



BY ORDERING A DOOR IN YOUR CANOPY, YOU CAN CREATE A HANDY REAR EXIT.

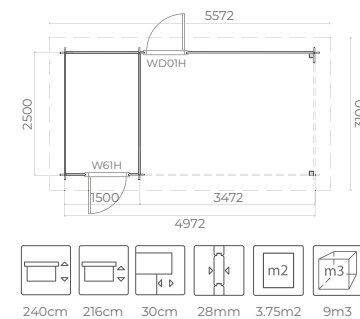

Dimensions excl. roof eaves: 250 x 500 cm

Doors: W61H, WD01H

Product code: 26083

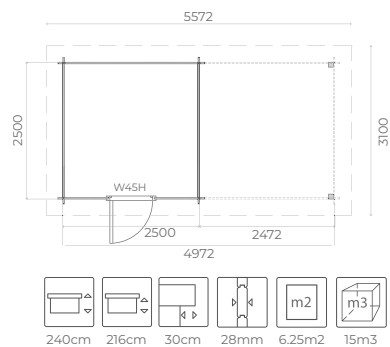

Dimensions excl. roof eaves: 250 x 500 cm

Door: W45H (without cross bars)

Product code: 28001

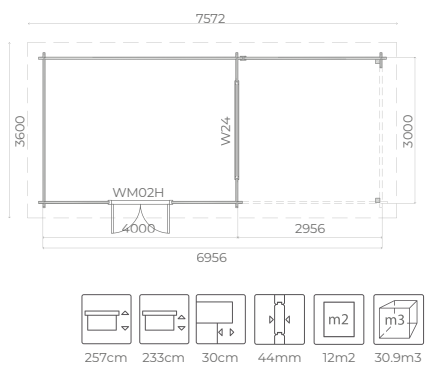

Dimensions excl. roof eaves: 300 x 700 cm

Door: WMO2H

Window: W24

Product code: 26559



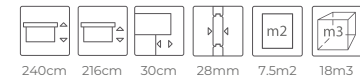
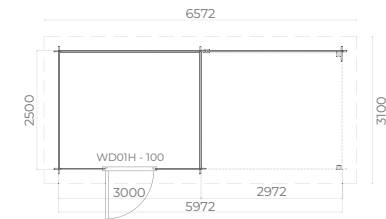

Dimensions excl. roof eaves: 250 x 600 cm

Door: WD01H - 100 cm

Product code: 28002

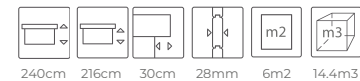
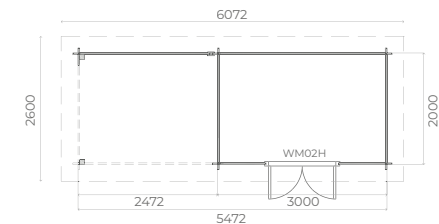

Dimensions excl. roof eaves: 200 x 550 cm

Door: WM02H

Product code: 26561

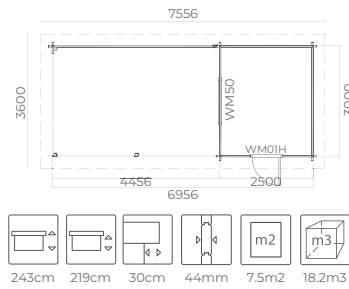

Dimensions excl. roof eaves: 300 x 700 cm

Door: WM01H (R/H hinged)

Windows: WM50

Product code: 26010



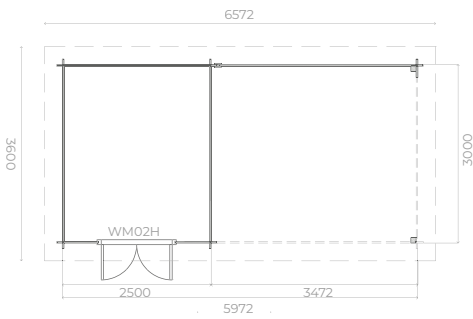

Dimensions excl. roof eaves: 300 x 600 cm

Door: WM02H

Product code: 27131

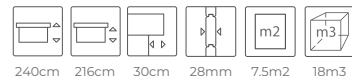

240cm 216cm 30cm 28mm 7.5m² 18m³



Dimensions excl. roof eaves: 250 x 550 cm

Door: W61H

Product code: 25294

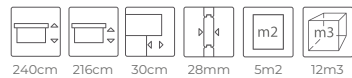
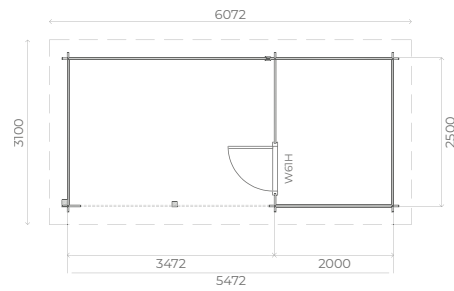

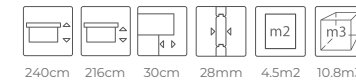
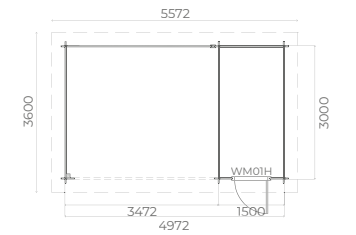

Dimensions excl. roof eaves: 300 x 500 cm

Door: WM01H (R/H hinged)

Product code: 26013

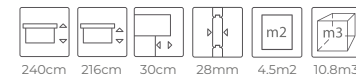
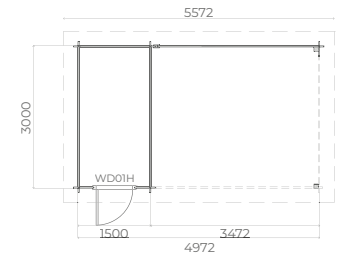

Dimensions excl. roof eaves: 300 x 500 cm

Door: WD01H

Product code: 26142

ALL OUR WINDOWS
AND DOORS COME WITH
DOUBLE GLAZING AS
STANDARD

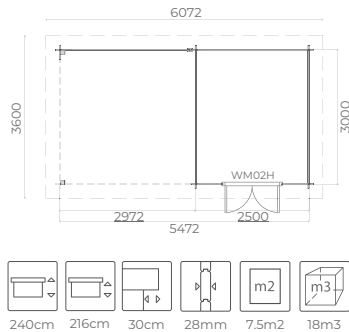

Dimensions excl. roof eaves: 300 x 550 cm

Door: WM02H (without cross bars)

Product code: 26109

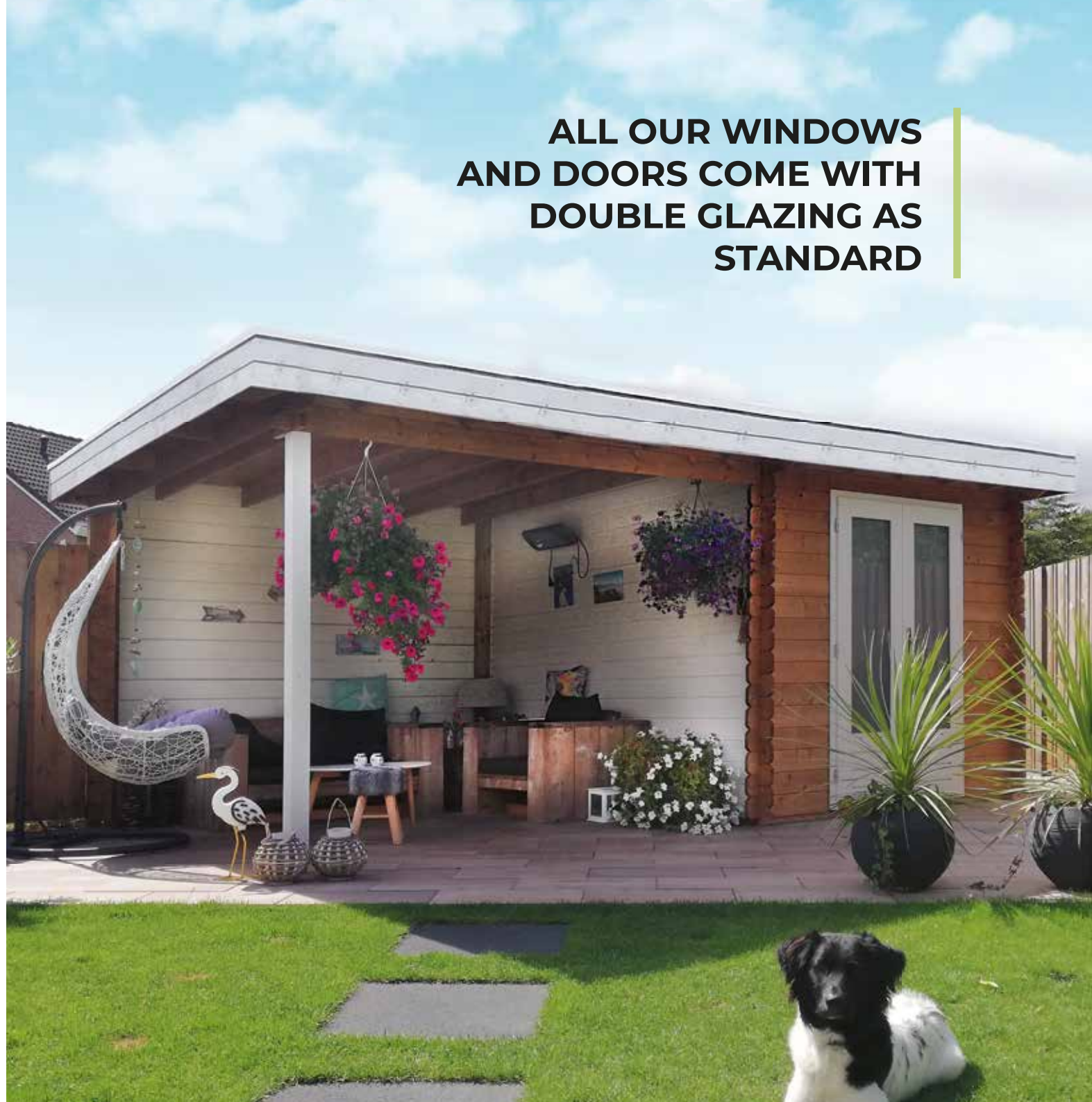



Would you like to fully adjust a model to your own wishes? You can! Go to the website: woodpro-configurator.com/brochure and enter the **product code**

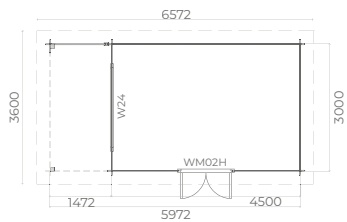

Dimensions excl. roof eaves: 300 x 600 cm

Door: WM02H

Window: W24

Product code: 27774

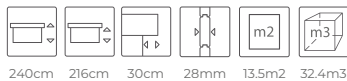

240cm 216cm 30cm 28mm 13.5m² 32.4m³

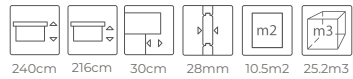
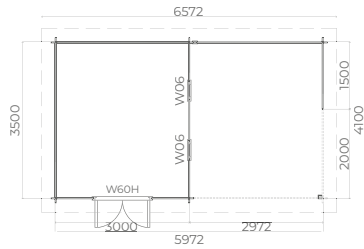

Dimensions excl. roof eaves: 350 x 600 cm

Door: W60H

Windows: 2 x W06

Product code: 28003

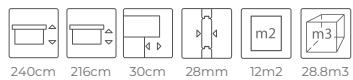
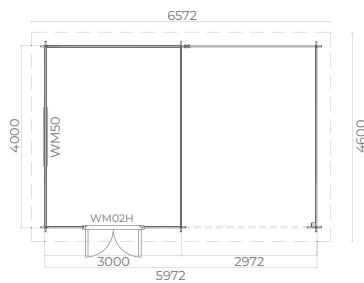

Dimensions excl. roof eaves: 400 x 600 cm

Door: W50H (without cross bars)

Windows: WM50

Product code: 28004



ENJOY THE
OUTDOORS

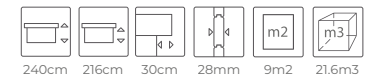
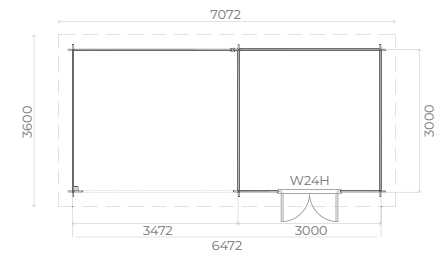

240cm 216cm 30cm 28mm 9m² 21.6m³

Dimensions excl. roof eaves: 300 x 650 cm

Door: W24H

Product code: 25188

FLAT ROOFS ARE DELIVERED COMPLETE WITH EPDM + ROOF OUTLET, SEALANT AND WIDE ALUMINIUM ROOF TRIMMINGS

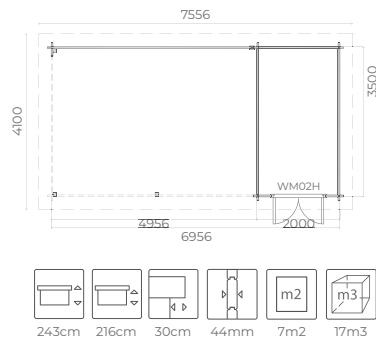

Dimensions excl. roof eaves: 350 x 700 cm

Door: WM02H

Product code: 25402

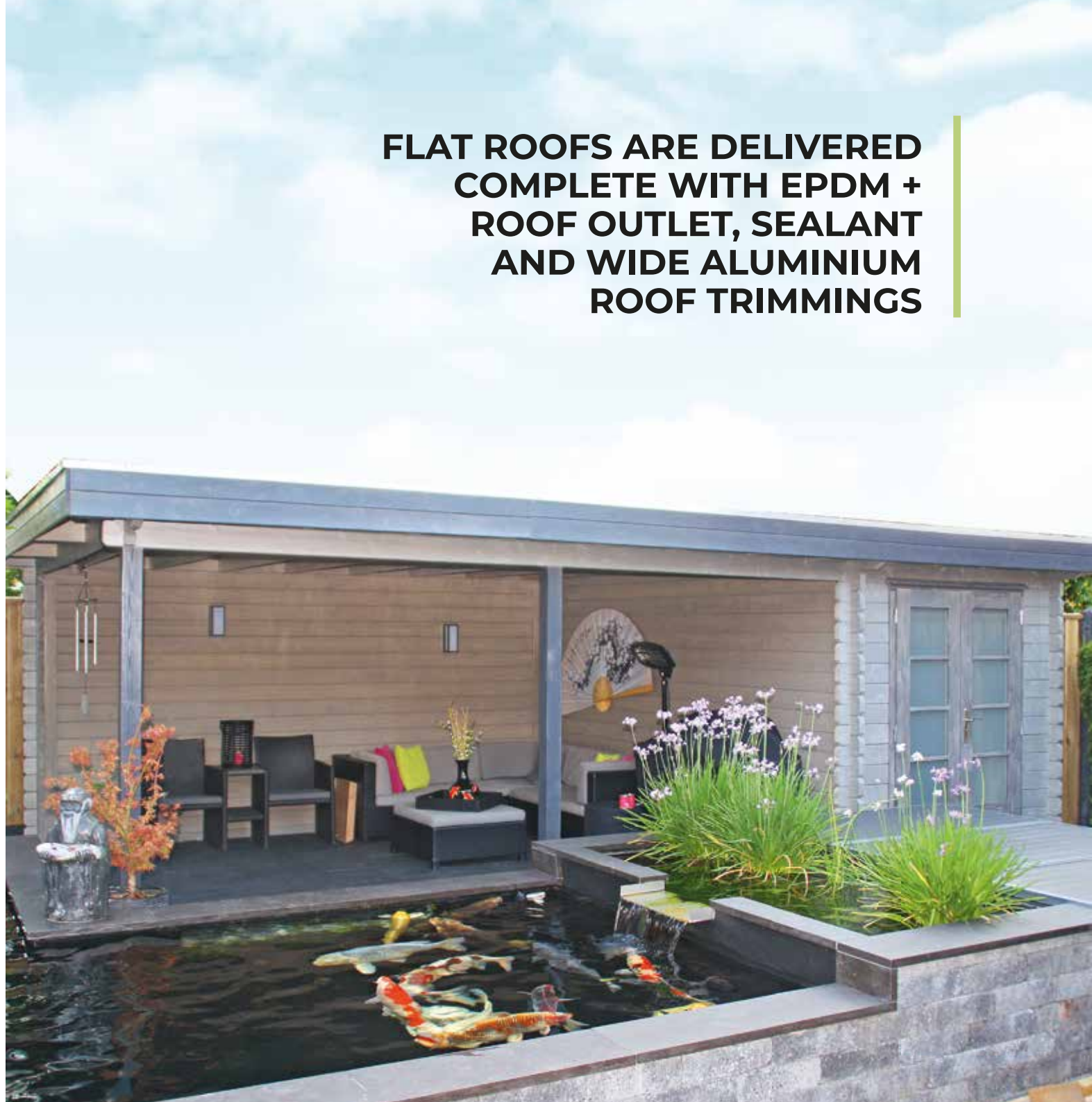

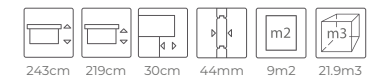
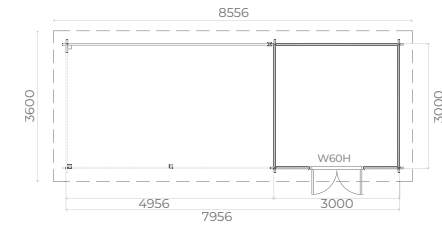

Dimensions excl. roof eaves: 300 x 800 cm

Door: W60H

Product code: 25185

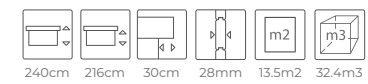
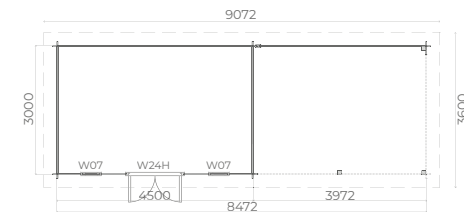

Dimensions excl. roof eaves: 300 x 850 cm

Door: W24H (without cross bars)

Windows: 2 x W07

Product code: 28005

Go to woodpro.co.uk and click on info to view various films about our **high quality wood** and **finish** of the windows and doors.

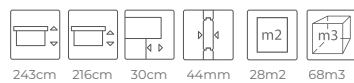
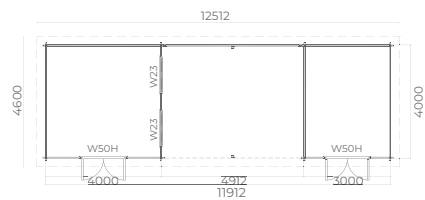

Dimensions excl. roof eaves: 400 x 1200 cm

Doors: 2 x W50H

Windows: 2 x W23

Product code: 26365





**ENJOY THE GARDEN
THE WHOLE YEAR**

LOG CABINS WITH A FLAT ROOF



STANDARD ADDITIONS

ALWAYS INCLUDED WITH US



All windows and doors are fitted with double glazing as standard



All windows, doors and posts are made of laminated wood (prevents warping)



All windows and doors are a whopping 4.5 cm thick

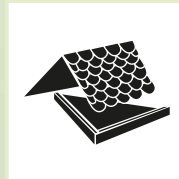

Includes complete roof package: EPDM for flat roofs.



Pressure impregnated foundation beams

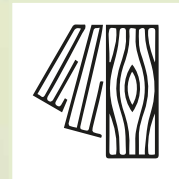

We use top-quality dried spruce wood

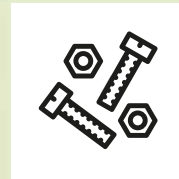

Including all the necessary fixing materials



5-year warranty on manufacturing and construction faults

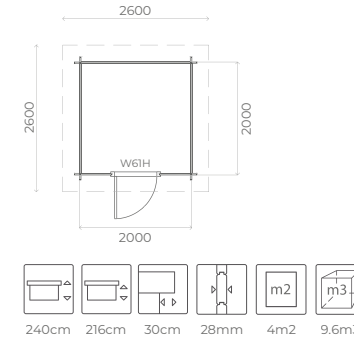

Dimensions excl. roof eaves: 200 x 200 cm

Door: W61H

Product code: 25309

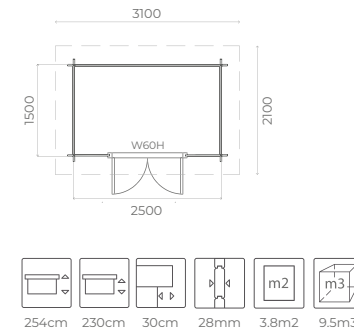

Dimensions excl. roof eaves: 150 x 250 cm

Door: W60H

Product code: 26381

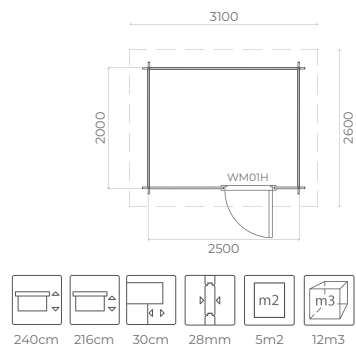

Dimensions excl. roof eaves: 200 x 250 cm

Door: WM01H (R/H hinged)

Product code: 26156

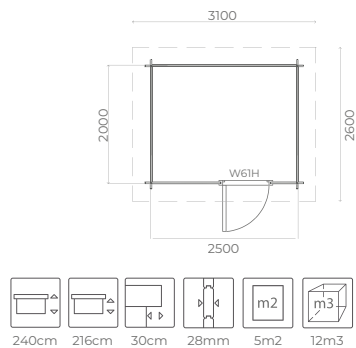

Dimensions excl. roof eaves: 200 x 250 cm

Door: W61H

Product code: 26193



LOMAX + WOOD logo featuring a tree ring graphic. Text: "Made-to-order garden rooms". Below the text is a stylized house icon with a roof and windows, flanked by two flowers. A registered trademark symbol (®) is present.

Would you like to fully adjust a model to your own wishes? You can! Go to the website: woodpro-configurator.com/brochure and enter the **product code**

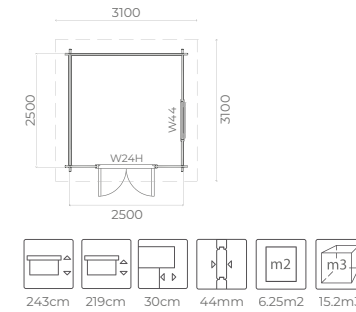

Dimensions excl. roof eaves: 250 x 250 cm
Door: W24H
Window: W44
Product code: 26403

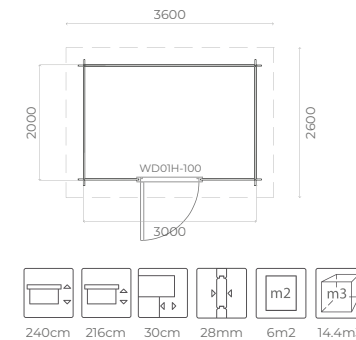

Dimensions excl. roof eaves: 200 x 300 cm
Door: WD01H - 100
Product code: 28006

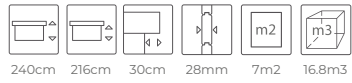
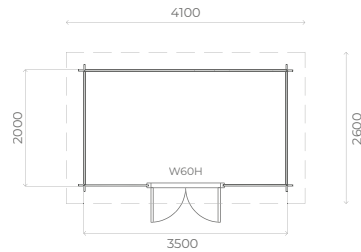

240cm 216cm 30cm 28mm 7m² 16.8m³

Dimensions excl. roof eaves: 200 x 350 cm

Door: W60H

Product code: 25150

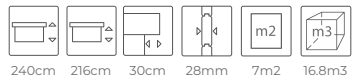
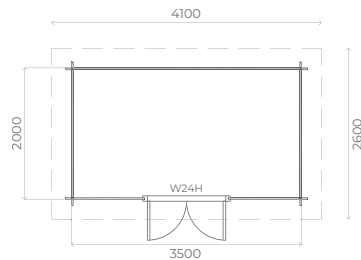

240cm 216cm 30cm 28mm 7m² 16.8m³

Dimensions excl. roof eaves: 200 x 350 cm

Door: W24H

Product code: 25133



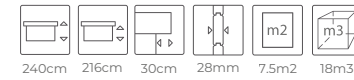
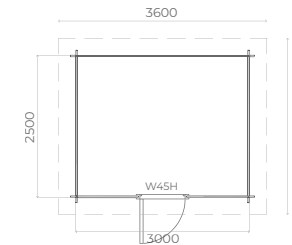

Dimensions excl. roof eaves: 250 x 300 cm

Door: W45H

Product code: 28007

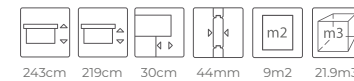
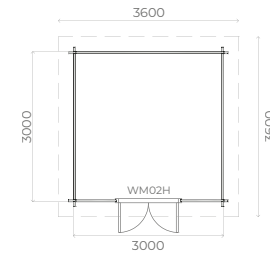

Dimensions excl. roof eaves: 300 x 300 cm

Door: WM02H

Product code: 25118



Go to woodpro.co.uk and click on info to view various films about our **high quality wood** and **finish** of the windows and doors.

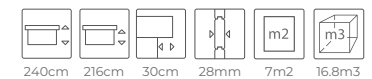
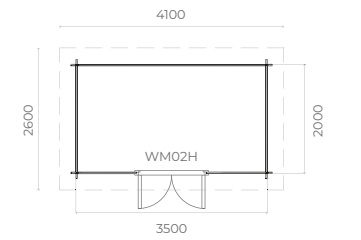

Dimensions excl. roof eaves: 350 x 200 cm
Door: WM02H
Product code: 27400

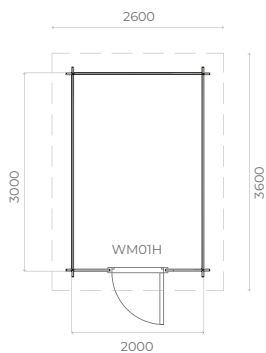

Dimensions excl. roof eaves: 300 x 200 cm

Door: WM01H (R/H hinged)

Product code: 27401

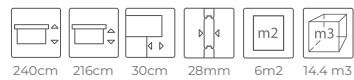

240cm 216cm 30cm 28mm 6m² 14.4 m³

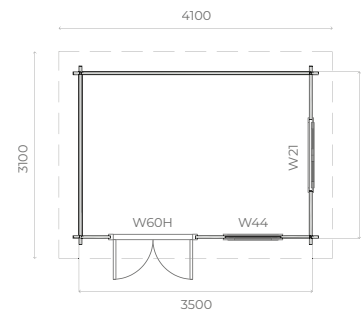

Dimensions excl. roof eaves: 350 x 250 cm

Door: W60H

Windows: W44 & W21

Product code: 28773

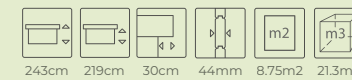

243cm 219cm 30cm 44mm 8.75m² 21.3m³

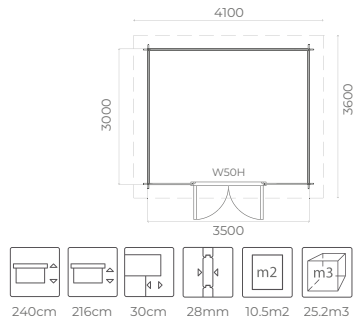

Dimensions excl. roof eaves: 300 x 350 cm

Door: W50H (without cross bars)

Product code: 28027

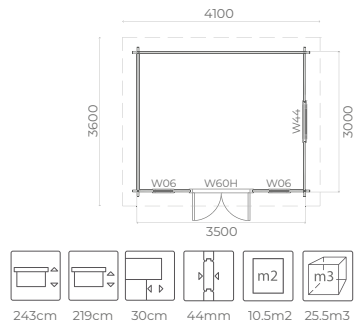

Dimensions excl. roof eaves: 300 x 350 cm

Door: W60H

Windows: 2 x W06, W44 (without cross bars)

Product code: 26475



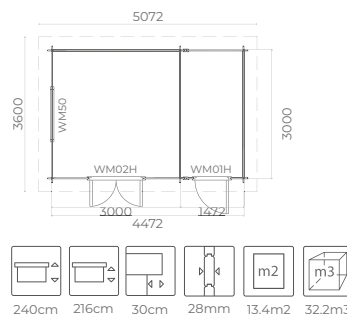

Dimensions excl. roof eaves: 300 x 450 cm

Door: WM02H, WM01H (R/H hinged)

Window: WM50

Product code: 27369

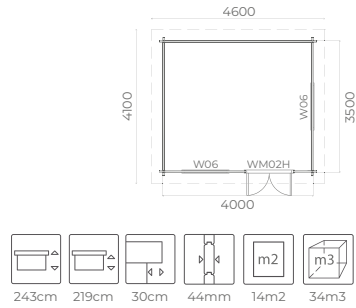

Dimensions excl. roof eaves: 350 x 400 cm

Door: WM02H

Windows: 2 x W06

Product code: 27188

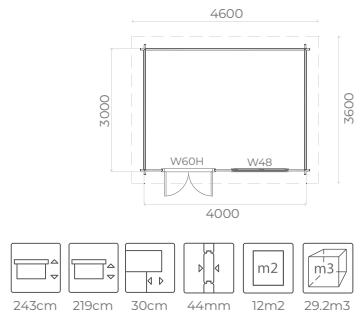

Dimensions excl. roof eaves: 300 x 400 cm

Door: W60H

Window: W48

Product code: 25120



**VERY HIGH-QUALITY WOOD
THAT IS DRIED TO REDUCE
SHRINKAGE AND EXPANSION**

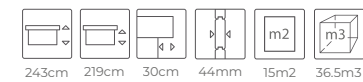
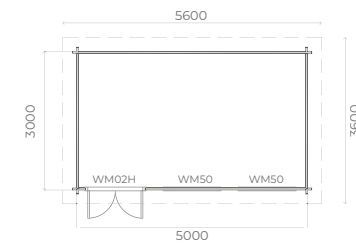

Dimensions excl. roof eaves: 300 x 500 cm

Door: WM02H

Windows: 2 x WM50

Product code: 25155

LOG CABINS WITH AN APEX ROOF AND A CANOPY



STANDARD ADDITIONS

ALWAYS INCLUDED WITH US

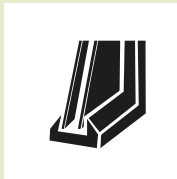

All windows and doors are fitted with double glazing as standard



All windows, doors and posts are made of laminated wood (prevents warping)



All windows and doors are a whopping 4.5 cm thick

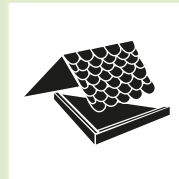

Roof shingles included. Choose from 5 colours (red, green, brown, blue or black)



Pressure impregnated foundation beams

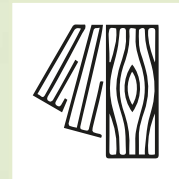

We use top-quality dried spruce wood

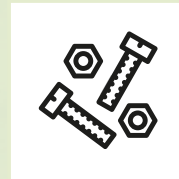

Including all the necessary fixing materials



5-year warranty on manufacturing and construction faults

Go to **woodpro.co.uk** and click on info to view various films about our **high quality wood** and **finish** of the windows and doors.

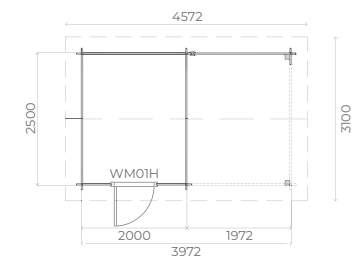

The benches in the photo are not included.

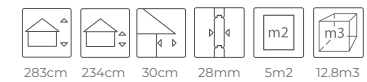

Dimensions excl. roof eaves: 250 x 400 cm

Door: WM01H

Product code: 25350

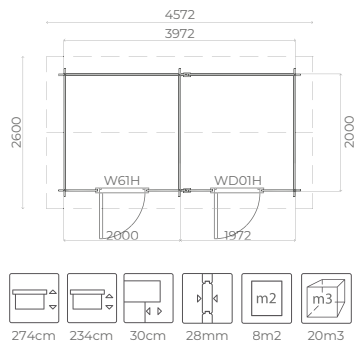

Dimensions excl. roof eaves: 200 x 400 cm

Doors: W61H, WD01H

Product code: 28008

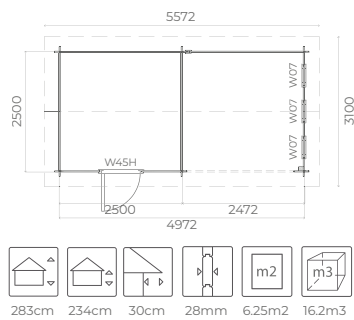

Dimensions excl. roof eaves: 250 x 500 cm

Door: W45H

Windows: 3 x W07

Product code: 28012



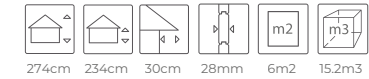
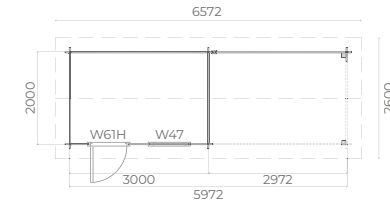

Dimensions excl. roof eaves: 200 x 600 cm

Door: W61H

Window: W47

Product code: 28010

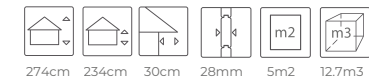
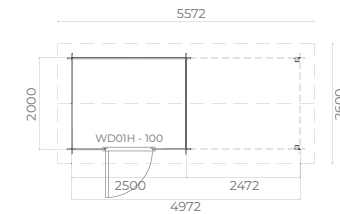

Dimensions excl. roof eaves: 200 x 500 cm

Door: WD01H-100

Product code: 28011

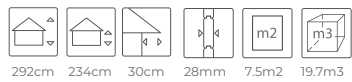
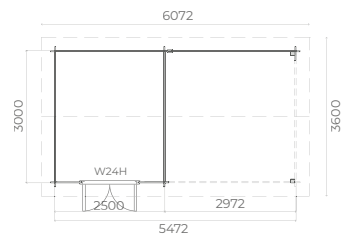

Dimensions excl. roof eaves: 300 x 550 cm

Door: W24H

Product code: 27160



CUSTOMISATION WITHOUT ANY ADDITIONAL CHARGES

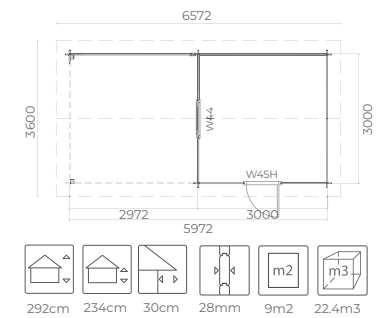

Dimensions excl. roof eaves: 300 x 600 cm

Door: W45H (R/H hinged)

Windows: W44

Product code: 27037

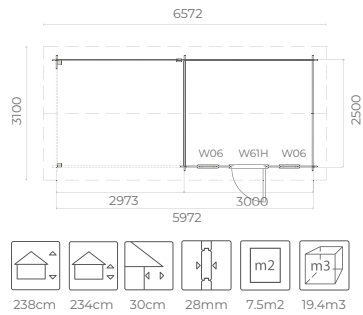

Dimensions excl. roof eaves: 250 x 600 cm

Door: W61H (R/H hinged)

Windows: 2 x W06

Product code: 28013

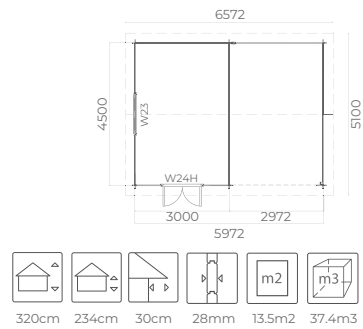

Dimensions excl. roof eaves: 450 x 600 cm

Door: W24H

Window: W23

Product code: 28014



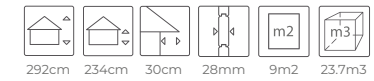
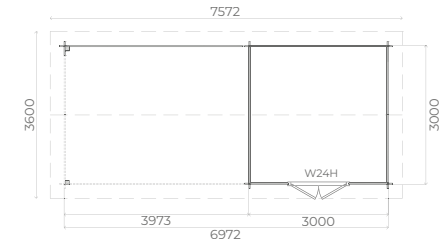

292cm 234cm 30cm 28mm 9m² 23.7m³

Dimensions excl. roof eaves: 300 x 700 cm

Door: W24H

Product code: 25102

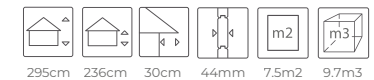
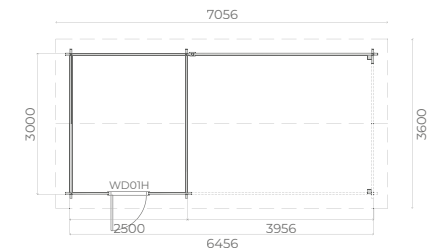

295cm 236cm 30cm 44mm 7.5m² 9.7m³

Dimensions excl. roof eaves: 300 x 650 cm

Door: WD01H

Product code: 26338

**WE USE
TOP-QUALITY
DRIED SPRUCE
WOOD**

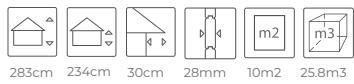
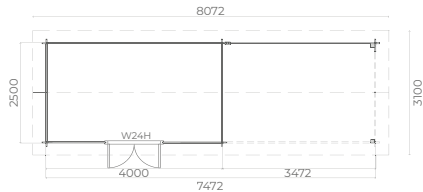

Dimensions excl. roof eaves: 250 x 750 cm

Door: W24H

Product code: 26284

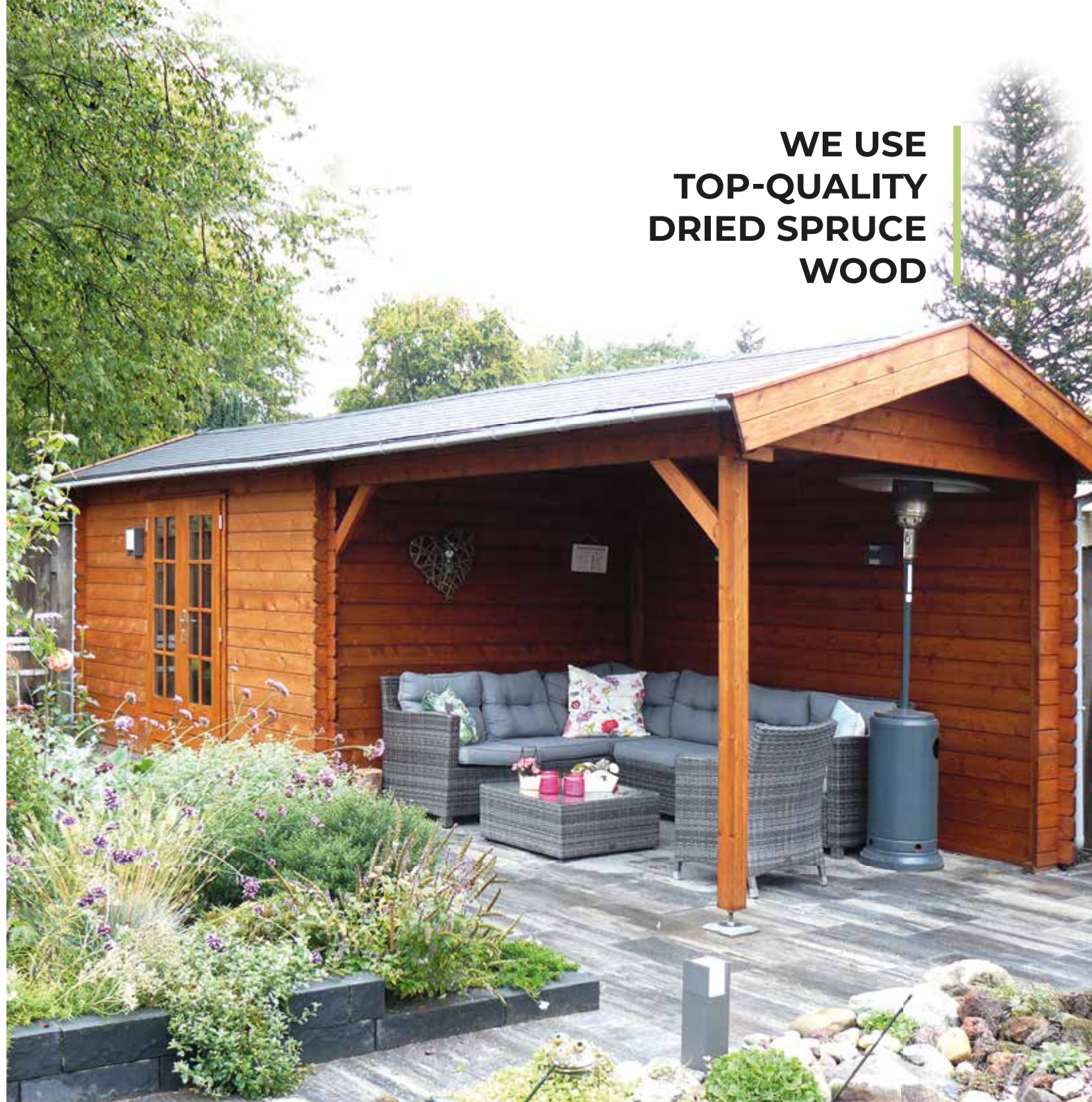

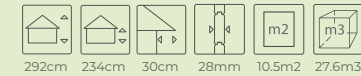
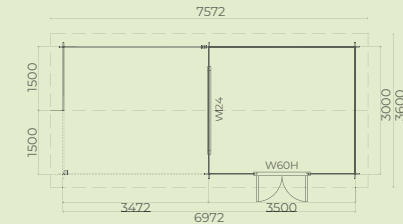

Dimensions excl. roof eaves: 300 x 700 cm

Door: W60H

Window: W24

Product code: 28015

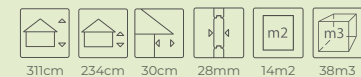
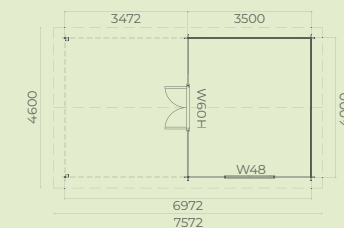

Dimensions excl. roof eaves: 400 x 700 cm

Door: W60H

Window: W48

Product code: 28009





Would you like to fully adjust a model to your own wishes? You can! Go to the website: woodpro-configurator.com/brochure and enter the **product code**

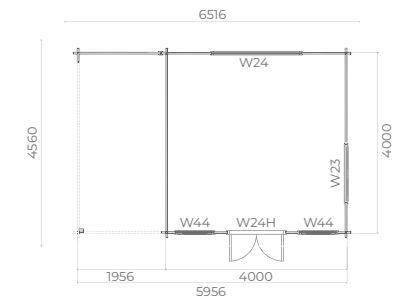

*Roof tile sheets and solar panels are not included.
Roof shingles are included as standard.*

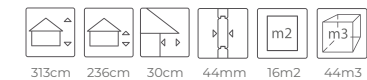

Dimensions excl. roof eaves: 400 x 600 cm
Door: W24H
Windows: W24, 2 x W44, W23 (without cross bars)
Product code: 25430

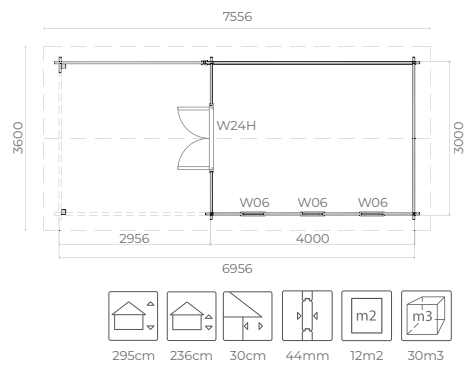

Dimensions excl. roof eaves: 300 x 700 cm

Door: W24H

Windows: 3x W06

Product code: 27646



Go to woodpro.co.uk and click on info to view various films about our **high quality wood** and **finish** of the windows and doors.

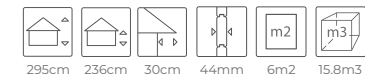
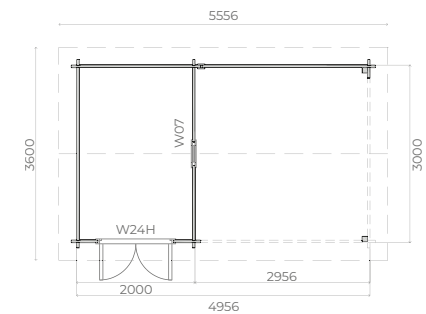

Dimensions excl. roof eaves: 300 x 500 cm

Door: W24H

Window: W07

Product code: 28174

LOG CABINS WITH AN APEX ROOF



STANDARD ADDITIONS

ALWAYS INCLUDED WITH US

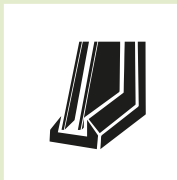

All windows and doors are fitted with double glazing as standard

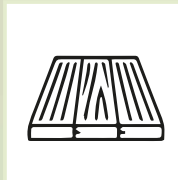

All windows, doors and posts are made of laminated wood (prevents warping)



All windows and doors are a whopping 4.5 cm thick

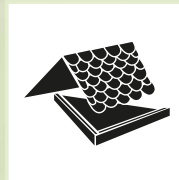

Roof shingles included. Choose from 5 colours (red, green, brown, blue or black)

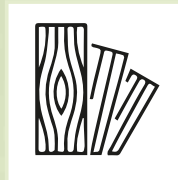

Pressure impregnated foundation beams

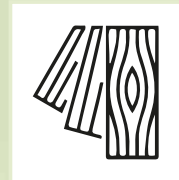

We use top-quality dried spruce wood

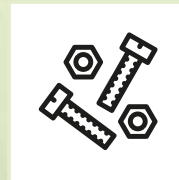

Including all the necessary fixing materials



5-year warranty on manufacturing and construction faults

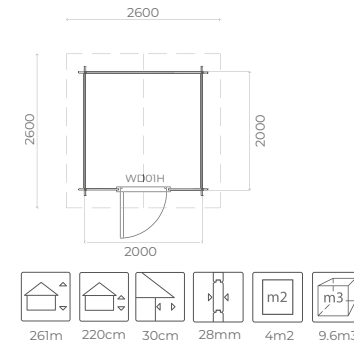

Dimensions excl. roof eaves: 200 x 200 cm

Door: WD01H

Product code: 28016

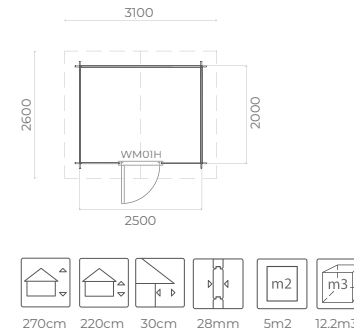

Dimensions excl. roof eaves: 200 x 250 cm

Door: WM01H

Product code: 28017

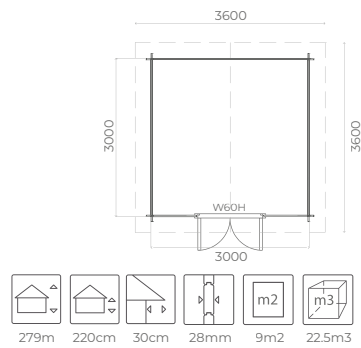

Dimensions excl. roof eaves: 300 x 300 cm

Door: W60H

Product code: 28019

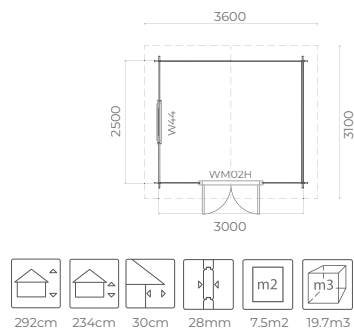

Dimensions excl. roof eaves: 250 x 300 cm

Door: WM02H

Windows: W44

Product code: 26508



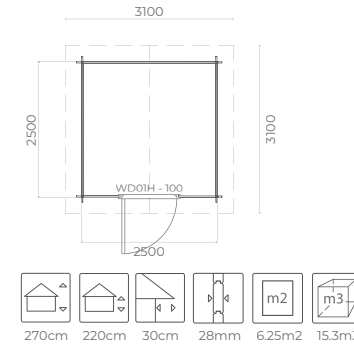

Dimensions excl. roof eaves: 250 x 250 cm

Door: WD01H - 100

Product code: 28018

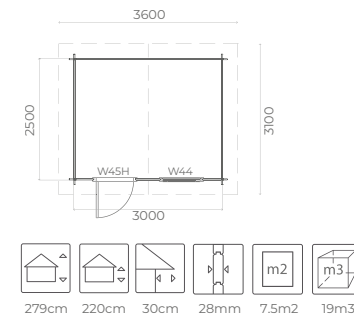

Dimensions excl. roof eaves: 250 x 300 cm

Door: W45H

Window: W44

Product code: 26485

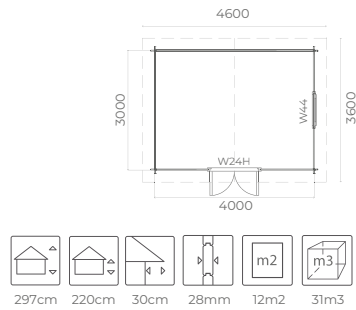

Dimensions excl. roof eaves: 300 x 400 cm

Door: W24H

Window: W44

Product code: 28020

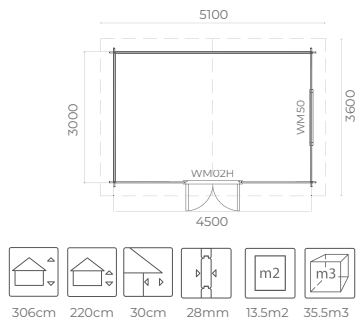

Dimensions excl. roof eaves: 300 x 450 cm

Door: WM02H

Window: WM50

Product code: 28021





**ENJOY YOUR
OWN GARDEN
OPTIMALLY**

GAZEBOS WITH A FLAT ROOF AND AN APEX ROOF



STANDARD ADDITIONS

ALWAYS INCLUDED
WITH US



All windows and doors are fitted with double glazing as standard



All windows, doors and posts are made of laminated wood (prevents warping)



All windows and doors are a whopping 4.5 cm thick



Includes complete roof package: EPDM for flat roofs or roof shingles for apex roofs

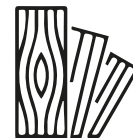

Pressure impregnated foundation beams

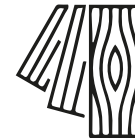

We use top-quality dried spruce wood

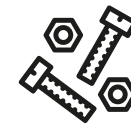

Including all the necessary fixing materials



5-year warranty on manufacturing and construction faults

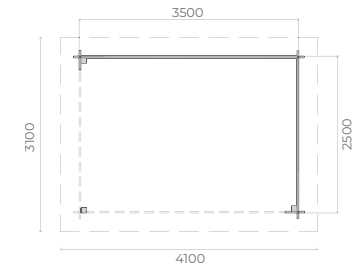

Dimensions excl. roof eaves: 250 x 350 cm

Product code: 26209

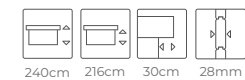
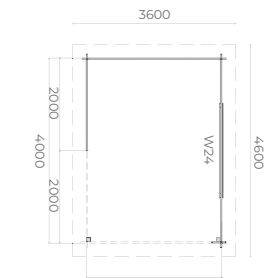

Dimensions excl. roof eaves: 300 x 400 cm

Window: W24

Product code: 28024

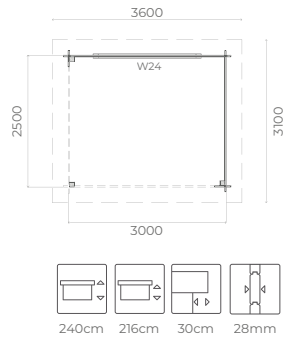

Dimensions excl. roof eaves: 250 x 300 cm

Window: W24

Product code: 28022

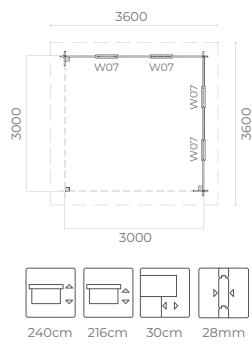

Dimensions excl. roof eaves: 300 x 300 cm

Windows: 4 x W07

Product code: 28023





**WITH A GAZEBO
IN YOUR GARDEN,
YOU CAN EVEN
BBQ IN BAD
WEATHER**

Would you like to fully adjust a model to your own wishes? You can! Go to the website: woodpro-configurator.com/brochure and enter the **product code**

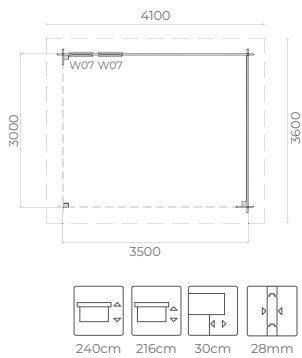

Dimensions excl. roof eaves: 300 x 350 cm

Windows: 2 x W07

Product code: 27198

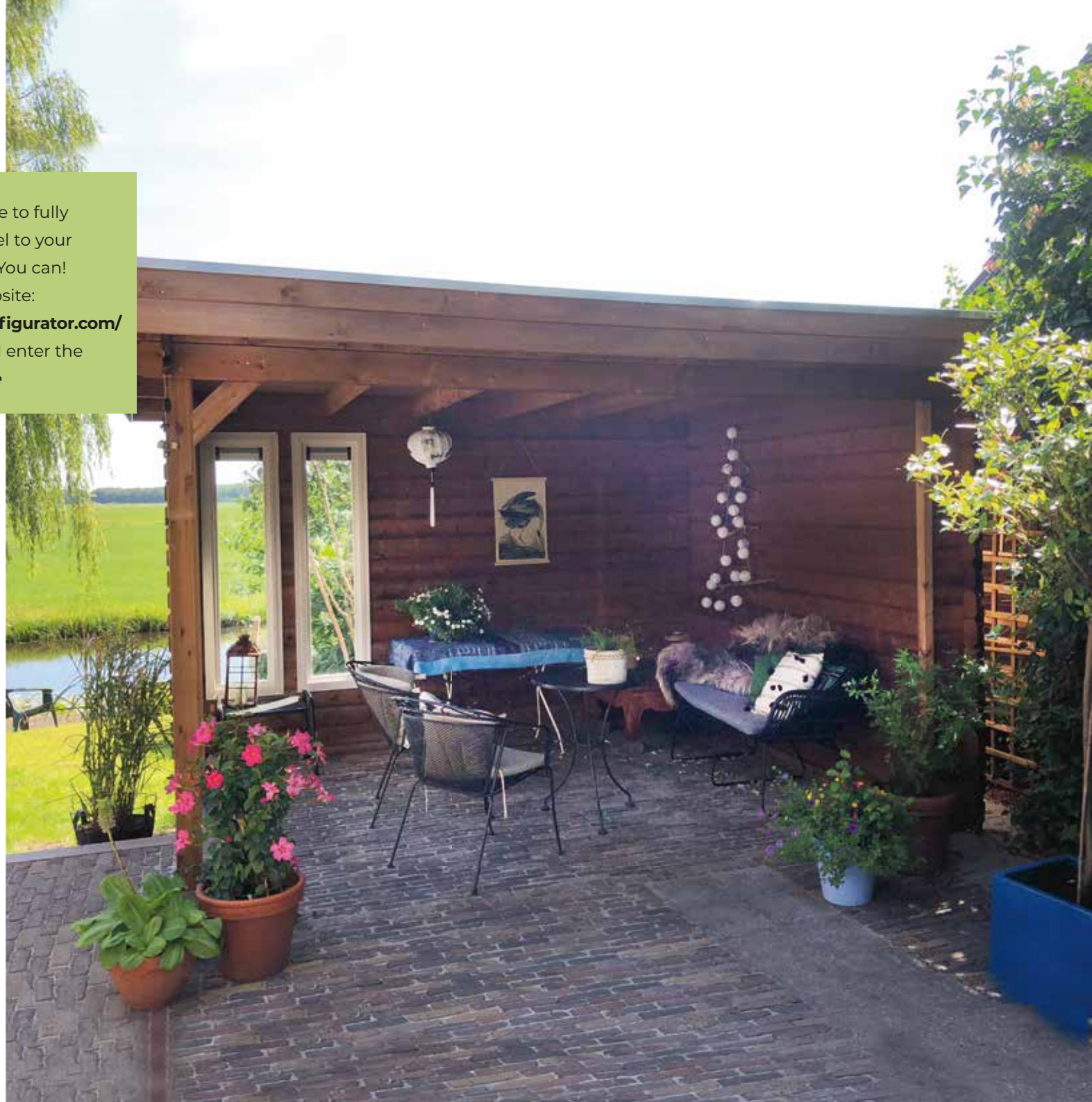

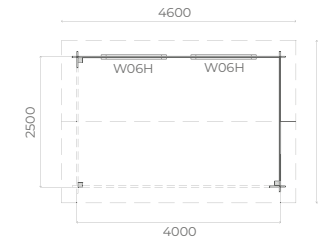

283cm 233cm 30cm 28mm

Dimensions excl. roof eaves: 250 x 400 cm

Windows: 2 x W06H

Product code: 28025

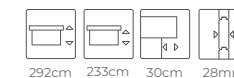
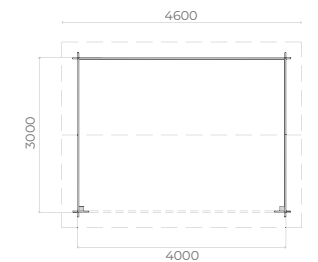

292cm 233cm 30cm 28mm

Dimensions excl. roof eaves: 300 x 400 cm

Product code: 28026

GARAGES WITH FLAT ROOF AND AN APEX ROOF



STANDARD ADDITIONS

ALWAYS INCLUDED WITH US



All windows and doors are fitted with double glazing as standard



All windows, doors and posts are made of laminated wood (prevents warping)



All windows and doors are a whopping 4.5 cm thick

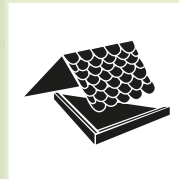

Includes complete roof package: EPDM for flat roofs or roof shingles for apex roofs



Pressure impregnated foundation beams

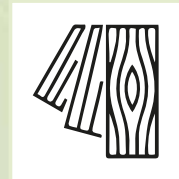

We use top-quality dried spruce wood

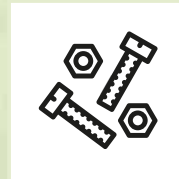

Including all the necessary fixing materials



5-year warranty on manufacturing and construction faults

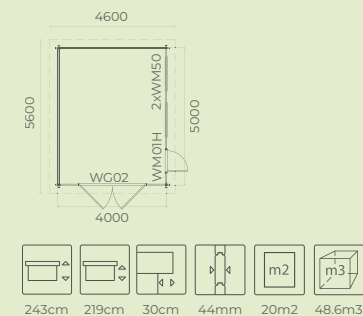

Dimensions excl. roof eaves: 300 x 700 cm

Doors: WG02 - WM01H

Windows: 2 x WM150

Product code: 26455

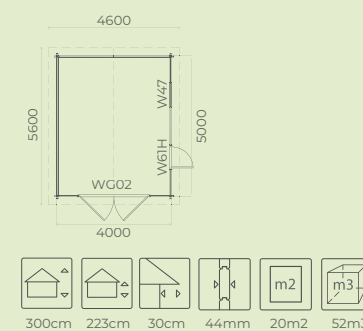

Dimensions excl. roof eaves: 400 x 500 cm

Doors: WG02 - W61H

Window: W47

Product code: 26454

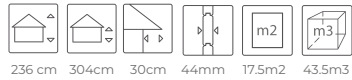
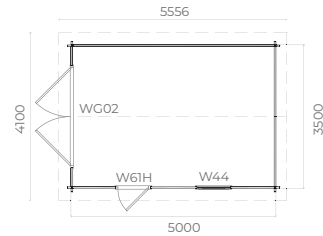

Dimensions excl. roof eaves: 350 x 500 cm

Door: WG02, W61H (R/H hinged)

Window: W44

Product code: 27363



Would you like to fully adjust a model to your own wishes? You can!
Go to the website: woodpro-configurator.com/brochure and enter the **product code**

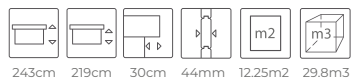
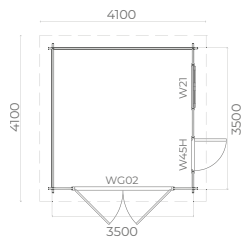

Dimensions excl. roof eaves: 350 x 350 cm

Door: WG02,W45H (R/H hinged)

Window: W21

Product code: 28028



WOULD YOU PREFER TO START FROM AN EMPTY TEMPLATE IN THE 3D CONFIGURATOR?

Go to: www.woodpro-configurator.com/brochure

Then enter the following product code:

LOG CABIN/GARAGE WITH AN APEX ROOF



Product code: BHZ

LOG CABIN/GARAGE WITH FLAT ROOF



Product code: BHP

GAZEBO WITH AN APEX ROOF



Product code: VERZ

GAZEBO WITH FLAT ROOF



Product code: VERP

Additions can be made very easily in the following way:

Garage

You can add a garage door in step 4.

Canopy/gazebo

Add a canopy by clicking on the wall in the floor plan and select: add a canopy.

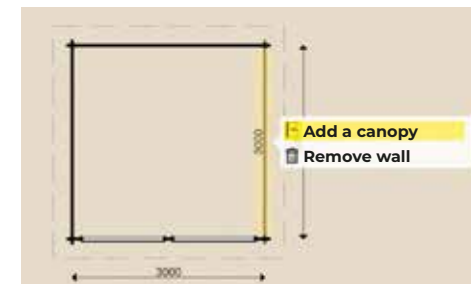

Tip! Both the walls of the log cabin and the dotted line of the canopy can be dragged with your mouse to achieve the desired dimensions.

In the steps that follow, you can then add windows/doors, floor, treatments, etc. to create your dream log cabin, gazebo or garage.

WINDOWS AND DOORS

- All windows and doors are made with double glazing
- All hinges are adjustable and have covers
- All windows and doors are made with laminated wood (prevents warping)
- All rods can be removed (and can be put back on) by means of a clicking system
- Tilt and turn windows turn inwards
- For all benefits, see pages 10 and 11 of this brochure

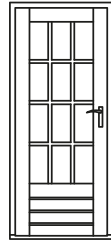

W45H
770 X 1935 mm

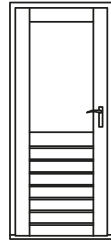

W61H
770 X 1935 mm

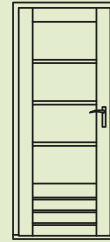

WM01H
770 X 1935 mm
(frosted glass)



WD01H
770 X 1935 mm

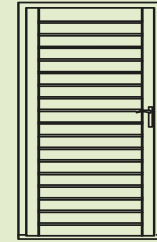

WD01H-100
1000 X 1935 mm

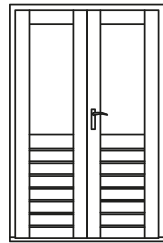

W60H
1210 X 1935 mm

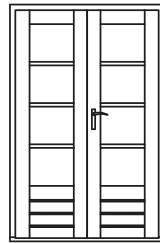

WM02H
1210 X 1935 mm
(frosted glass)

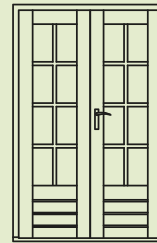

W24H
1210 X 1935 mm

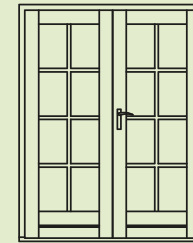

W50H
1510 X 1935 mm

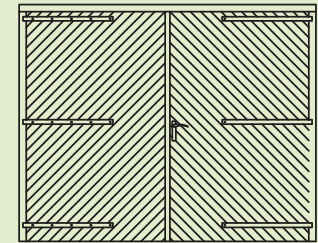

WG02
2290 X 2000
(side hinged)

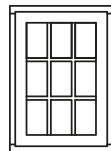

W44
770 X 1140 mm
(top-hung)

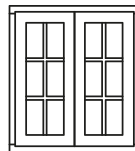

W21
1000 X 1140 mm

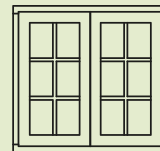

W23
1210 X 1140 mm

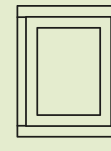

W47
770 X 1000 mm
(tilt and turn)

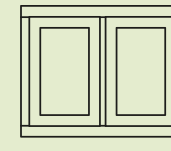

W48
1290 X 1000 mm
(tilt and turn)



W05
340 X 730 mm
(fixed)



W06
340 X 1140 mm
(fixed)

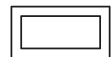

W05H
730 X 340 mm
(fixed)

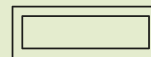

W06H
1140 X 340 mm
(fixed)

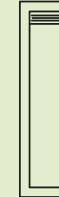

W07 with ventilation grille
340 X 1530 mm (fixed)

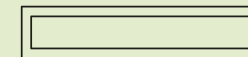

W24
1935 X 340 mm
(fixed)

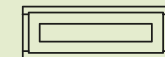

WM50
1140 X 340 mm
(top-hung + frosted glass)



All products are delivered roadside only. Sizes: the sizes specified in this brochure are approximate sizes. Warranty and complaints: we offer a five-year warranty on manufacturing and construction faults. Damage caused by humans, animals or natural disasters is not covered by the warranty. Claims resulting from a bad foundation or a faulty assembly, poor maintenance and/or a faulty maintenance agent are not covered by the warranty. It is not permitted to copy, reproduce or use models of log cabins, gazebos, building systems, building plans, photographs and/or text from this brochure or from our websites, in whole or in part, in any way whatsoever, without our written permission. All orders placed with us, based on this brochure or configurator, are subject to the general terms and conditions of WoodPro. These general terms and conditions can be requested from us. Price, model and material changes and printing errors reserved. All products are delivered untreated as standard. Publication of 2020 brochure.

WOODPRO

Your woodpro dealer:



www.lomaxwoodgardenrooms.co.uk

E: sales@lomaxwoodgardenrooms.co.uk

T: 01277 353857

For news, tips and information follow us on:

 [Woodproblokhutten](#)  [WoodproUK](#)

WWW.WOODPRO.CO.UK

Woodpro Netherlands

Tel.no: 0031 85 047 94 73

Email: info@woodpro.nl